



Low V_F High Current Density Surface Mount Schottky Barrier Rectifiers

eSMP™ Series



TO-277A (SMPC)

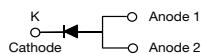

FEATURES

- Very low profile - typical height of 1.1 mm
- Ideal for automated placement
- Low forward voltage drop, low power losses
- High efficiency
- Low thermal resistance
- Meets MSL level 1, per J-STD-020, LF maximum peak of 260 °C
- AEC-Q101 qualified
- Compliant to RoHS directive 2002/95/EC and in accordance to WEEE 2002/96/EC
- **Halogen-free according to IEC 61249-2-21 definition**

AUTOMOTIVE
GRADE
Available



RoHS
COMPLIANT
HALOGEN
FREE

PRIMARY CHARACTERISTICS

$I_{F(AV)}$	3.0 A
V_{RRM}	50 V, 60 V
I_{FSM}	150 A
E_{AS}	20 mJ
V_F at $I_F = 3.0$ A	0.478 V
T_J max.	150 °C

TYPICAL APPLICATIONS

For use in low voltage high frequency inverters, freewheeling, dc-to-dc converters and polarity protection applications.

MECHANICAL DATA

Case: TO-277A (SMPC)

Molding compound meets UL 94 V-0 flammability rating

Base P/N-M3 - halogen-free and RoHS compliant, commercial grade

Base P/NHM3 - halogen-free and RoHS compliant, automotive grade

Terminals: Matte tin plated leads, solderable per J-STD-002 and JESD 22-B102

M3 suffix meets JESD 201 class 1A whisker test, HM3 suffix meets JESD 201 class 2 whisker test

MAXIMUM RATINGS ($T_A = 25$ °C unless otherwise noted)

PARAMETER	SYMBOL	SS3P5L	SS3P6L	UNIT
Device marking code		S35	S36	
Maximum repetitive peak reverse voltage	V_{RRM}	50	60	V
Maximum average forward rectified current (fig. 1)	$I_{F(AV)}$	3.0		A
Peak forward surge current 10 ms single half sine-wave superimposed on rated load	I_{FSM}	150		A
Non-repetitive avalanche energy at $I_{AS} = 2$ A, $T_J = 25$ °C	E_{AS}	20		mJ
Operating junction and storage temperature range	T_J, T_{STG}	- 55 to + 150		°C

SS3P5L, SS3P6L

Vishay General Semiconductor



ELECTRICAL CHARACTERISTICS (T _A = 25 °C unless otherwise noted)						
PARAMETER	TEST CONDITIONS		SYMBOL	TYP.	MAX.	UNIT
Maximum instantaneous forward voltage ⁽¹⁾	I _F = 1.5 A	T _A = 25 °C	V _F	0.464	-	V
	I _F = 3.0 A			0.542	0.60	
	I _F = 1.5 A	T _A = 125 °C		0.379	-	
	I _F = 3.0 A			0.478	0.54	
Maximum reverse current ⁽²⁾	Rated V _R	T _A = 25 °C	I _R	8.4	150	μA
		T _A = 125 °C		3.4	15	
Typical junction capacitance	4.0 V, 1 MHz		C _J	200	-	pF

Notes⁽¹⁾ Pulse test: 300 μs pulse width, 1 % duty cycle⁽²⁾ Pulse test: Pulse width ≤ 40 ms

THERMAL CHARACTERISTICS (T _A = 25 °C unless otherwise noted)				
PARAMETER	SYMBOL	SS3P5L	SS3P6L	UNIT
Typical thermal resistance	R _{θJA} ⁽¹⁾	65		°C/W
	R _{θJL}	3		

Note⁽¹⁾ Units mounted on recommended P.C.B. 1 oz. pad layout

ORDERING INFORMATION (Example)				
PREFERRED P/N	UNIT WEIGHT (g)	PREFERRED PACKAGE CODE	BASE QUANTITY	DELIVERY MODE
SS3P5L-M3/86A	0.10	86A	1500	7" diameter plastic tape and reel
SS3P5L-M3/87A	0.10	87A	6500	13" diameter plastic tape and reel
SS3P5LHM3/86A ⁽¹⁾	0.10	86A	1500	7" diameter plastic tape and reel
SS3P5LHM3/87A ⁽¹⁾	0.10	87A	6500	13" diameter plastic tape and reel

Note⁽¹⁾ Automotive grade



RATINGS AND CHARACTERISTICS CURVES

($T_A = 25\text{ }^\circ\text{C}$ unless otherwise noted)

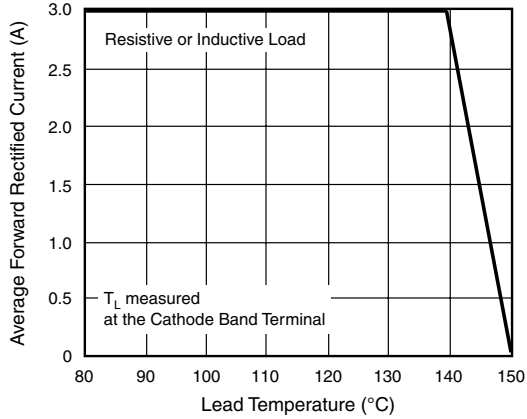

Figure 1. Maximum Forward Current Derating Curve

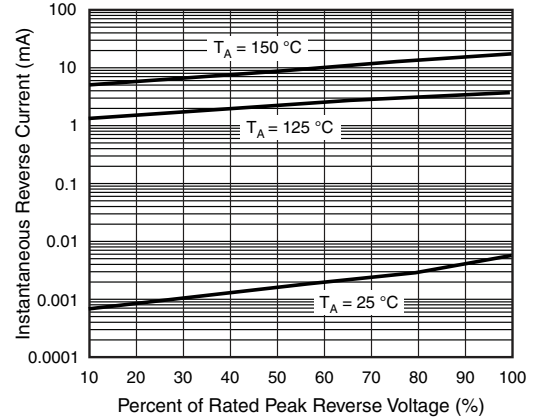

Figure 4. Typical Reverse Characteristics

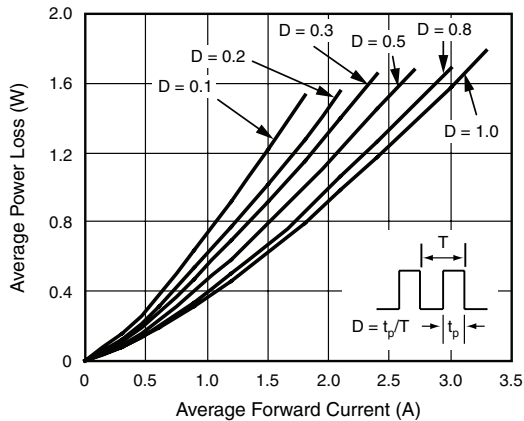

Figure 2. Forward Power Loss Characteristics

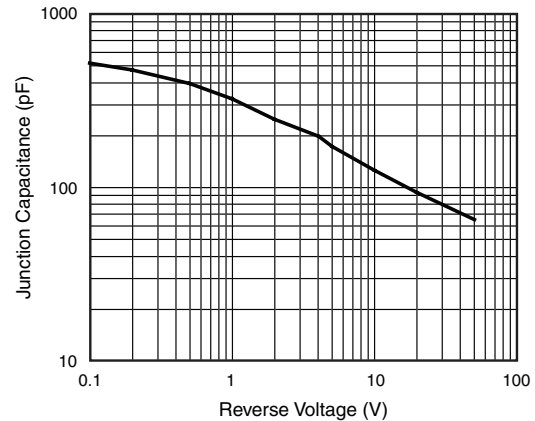

Figure 5. Typical Junction Capacitance

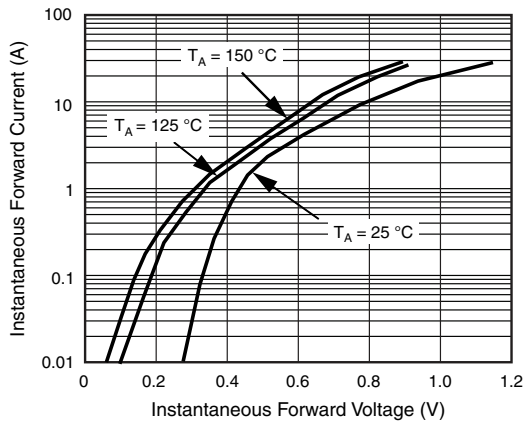

Figure 3. Typical Instantaneous Forward Characteristics

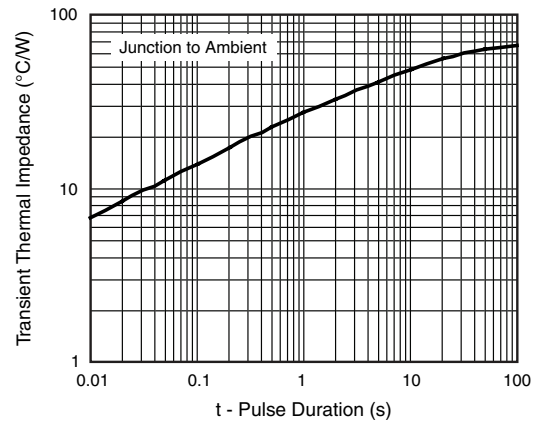
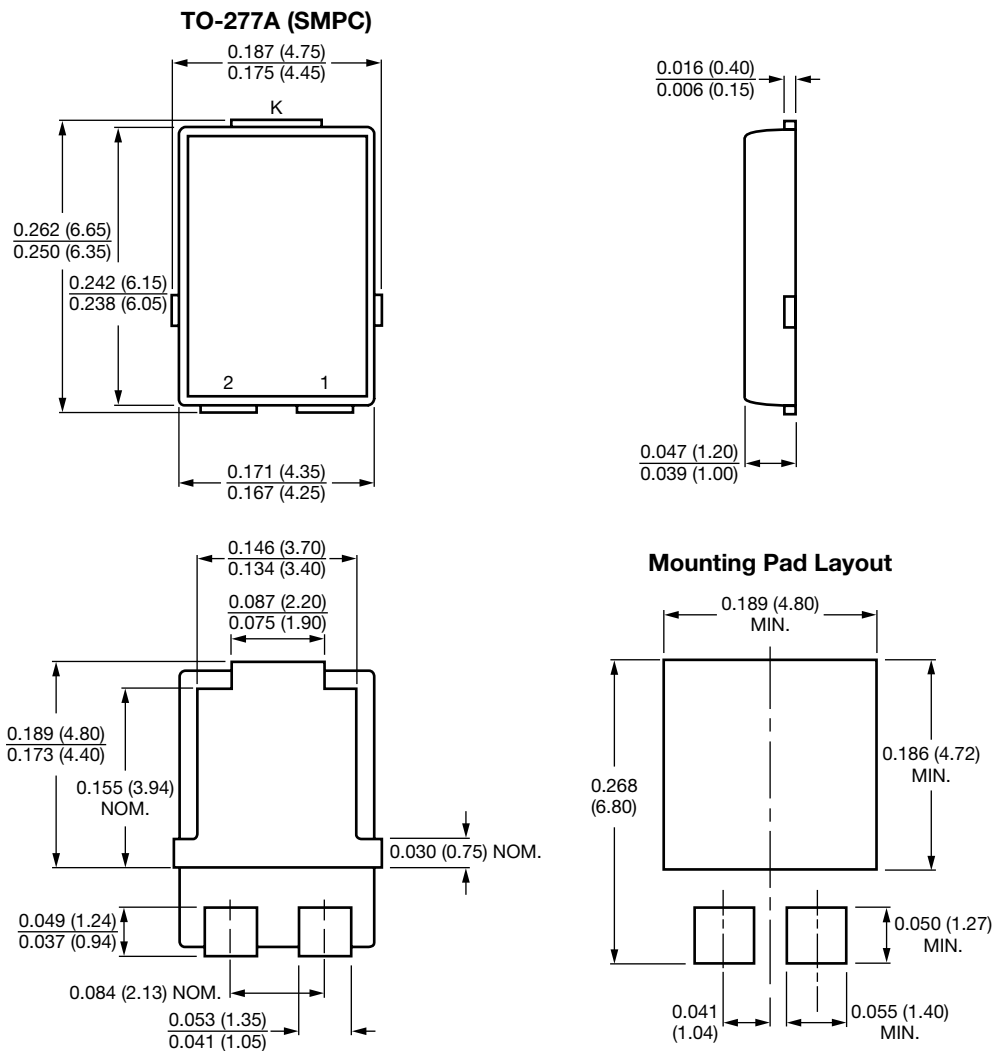

Figure 6. Typical Transient Thermal Impedance

PACKAGE OUTLINE DIMENSIONS in inches (millimeters)



Conform to JEDEC TO-277A



Disclaimer

All product specifications and data are subject to change without notice.

Vishay Intertechnology, Inc., its affiliates, agents, and employees, and all persons acting on its or their behalf (collectively, "Vishay"), disclaim any and all liability for any errors, inaccuracies or incompleteness contained herein or in any other disclosure relating to any product.

Vishay disclaims any and all liability arising out of the use or application of any product described herein or of any information provided herein to the maximum extent permitted by law. The product specifications do not expand or otherwise modify Vishay's terms and conditions of purchase, including but not limited to the warranty expressed therein, which apply to these products.

No license, express or implied, by estoppel or otherwise, to any intellectual property rights is granted by this document or by any conduct of Vishay.

The products shown herein are not designed for use in medical, life-saving, or life-sustaining applications unless otherwise expressly indicated. Customers using or selling Vishay products not expressly indicated for use in such applications do so entirely at their own risk and agree to fully indemnify Vishay for any damages arising or resulting from such use or sale. Please contact authorized Vishay personnel to obtain written terms and conditions regarding products designed for such applications.

Product names and markings noted herein may be trademarks of their respective owners.